

product catalogue

2014



Smart ideas for Smart creations

 **aapple**TM
WE DEVELOP THE FUTURE
KITCHEN BASKET & ACCESSORIES

Red

“ Enough space to put cups and saucers separately and still close to each other. Thin steel rods with given enough space helps keep all crockery dry. Proper space between two saucers so that it does not break even if they are handled without much care. ”

CUP & SAUCER BASKET		
Width	375, 425, 475, 525	(mm)
Depth	505, 555	(mm)
Height	100	(mm)
Width	15, 17, 19, 21	(inch)
Depth	20, 22	(inch)
Height	4	(inch)



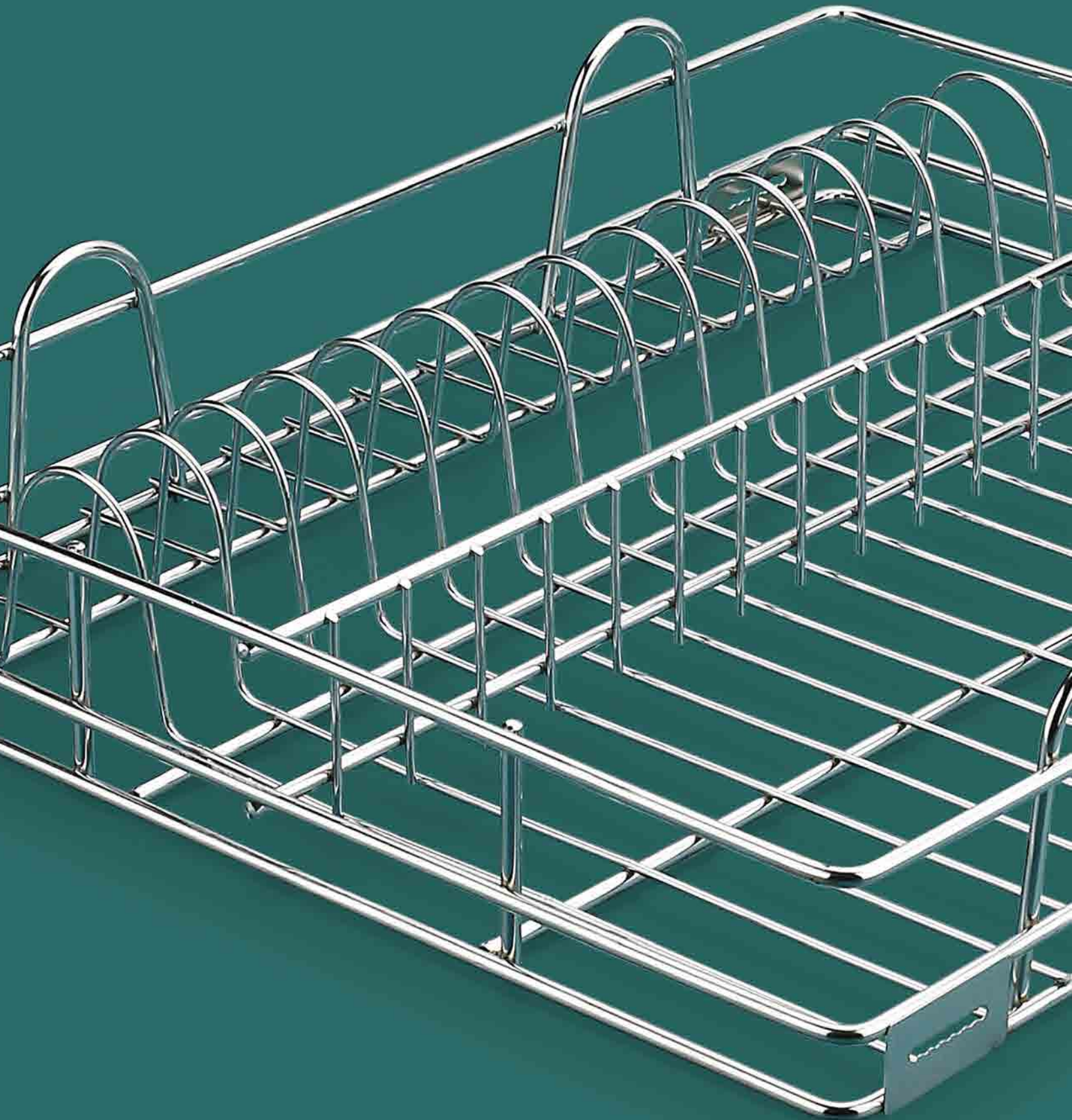

Red



CUP & SAUCER BASKET

Width	375, 425, 475, 525	(mm)
Depth	505, 555	(mm)
Height	100	(mm)
Width	15, 17, 19, 21	(inch)
Depth	20, 22	(inch)
Height	4	(inch)

PERFORATED CUTLERY BASKET

Width	375, 425, 475, 525	(mm)
Depth	505, 555	(mm)
Height	100	(mm)
Width	15, 17, 19, 21	(inch)
Depth	20, 22	(inch)
Height	4	(inch)

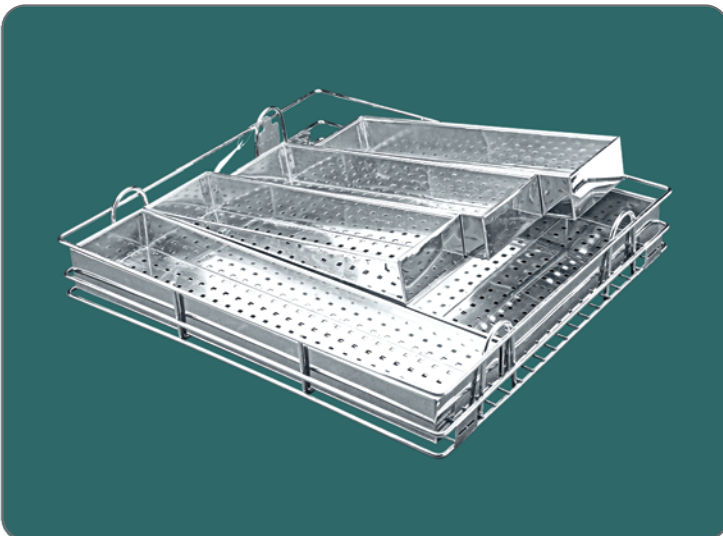
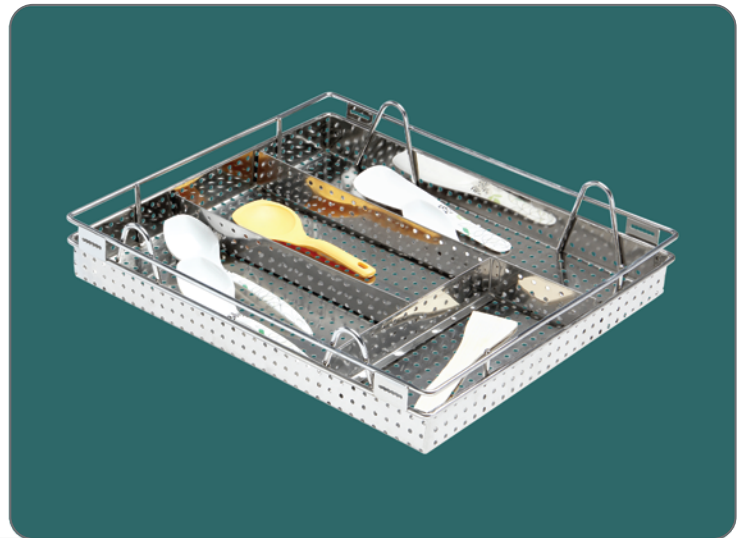

PERFORATED BOX CUTLERY BASKET

Width	375, 425, 475, 525	(mm)
Depth	505, 555	(mm)
Height	100	(mm)
Width	15, 17, 19, 21	(inch)
Depth	20, 22	(inch)
Height	4	(inch)

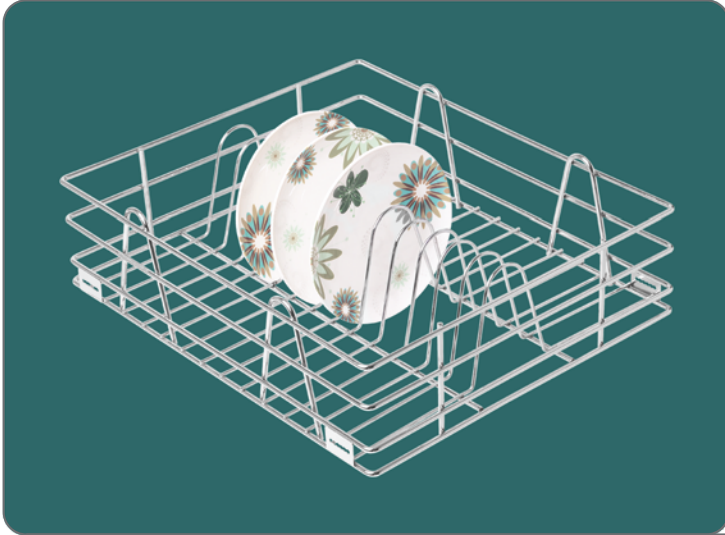

DISH BASKET

Width	375, 425, 475, 525	(mm)
Depth	505, 555	(mm)
Height	150	(mm)
Width	15, 17, 19, 21	(inch)
Depth	20, 22	(inch)
Height	6	(inch)

THALI BASKET

Width	375, 425, 475, 525	(mm)
Depth	505, 555	(mm)
Height	200	(mm)
Width	15, 17, 19, 21	(inch)
Depth	20, 22	(inch)
Height	8	(inch)

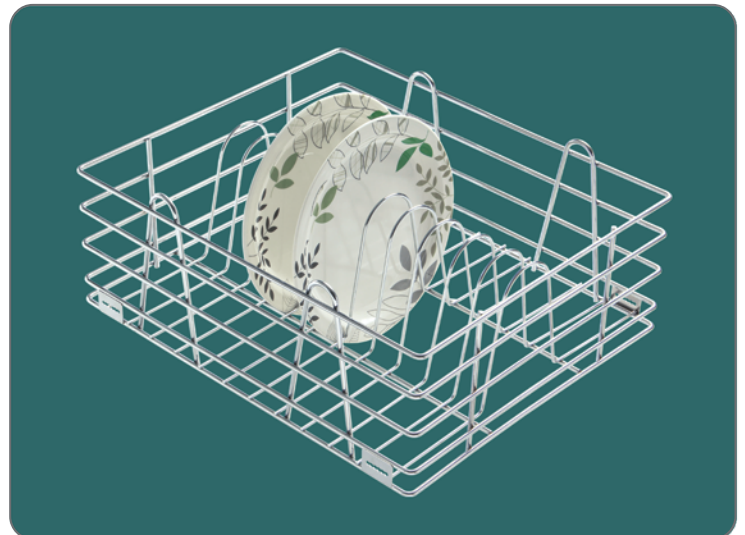

PLAIN BASKET

Width	375, 425, 475, 525	(mm)
Depth	505, 555	(mm)
Height	100, 150, 200	(mm)
Width	15, 17, 19, 21	(inch)
Depth	20, 22	(inch)
Height	4, 6, 8	(inch)

Red



PARTITION BASKET

Width	375, 425, 475, 525	(mm)
Depth	505, 555	(mm)
Height	100, 150, 200	(mm)
Width	15, 17, 19, 21	(inch)
Depth	20, 22	(inch)
Height	4, 6, 8	(inch)

GLASS BASKET

Width	375, 425, 475, 525	(mm)
Depth	505, 555	(mm)
Height	100	(mm)
Width	15, 17, 19, 21	(inch)
Depth	20, 22	(inch)
Height	4	(inch)

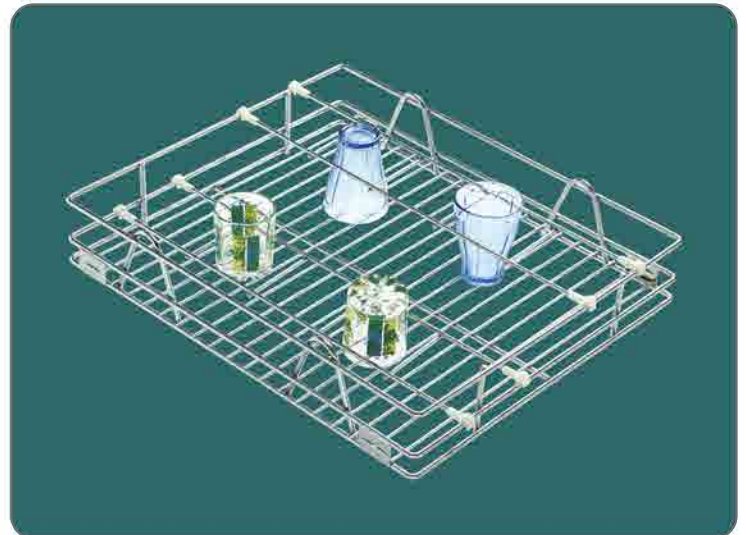

BOTTLE BASKET

Width	375, 425, 475, 525	(mm)
Depth	505, 555	(mm)
Height	150	(mm)
Width	15, 17, 19, 21	(inch)
Depth	20, 22	(inch)
Height	6	(inch)



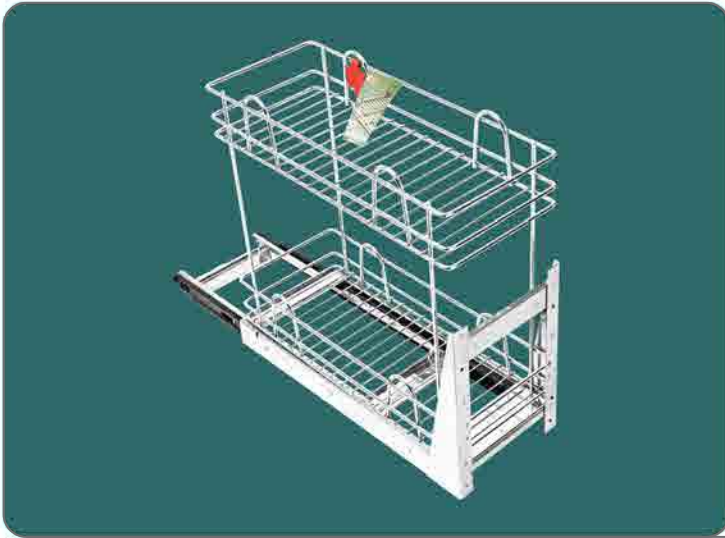

GRAIN PULL OUT WITH S.S. FRAME 2 SELF

Width	300, 200, 150	(mm)
Depth	505, 550	(mm)
Height	425	(mm)
Width	12, 8, 6	(inch)
Depth	20, 22	(inch)
Height	17	(inch)

GRAIN PULL OUT WITH S.S. FRAME 3 SELF

Width	300, 200, 150	(mm)
Depth	505, 550	(mm)
Height	600	(mm)
Width	12, 8, 6	(inch)
Depth	20, 22	(inch)
Height	24	(inch)





Green

“ Every cutlery has its own space according to its shape and size. Place them conveniently in perforated steel sheet that keeps air come and go. This help cutlery remain dry and clean all the time. ”

PERFORATED CUTLERY BASKET

Width	375, 425, 475, 525	(mm)
Depth	505, 555	(mm)
Height	100	(mm)
Width	15, 17, 19, 21	(inch)
Depth	20, 22	(inch)
Height	4	(inch)

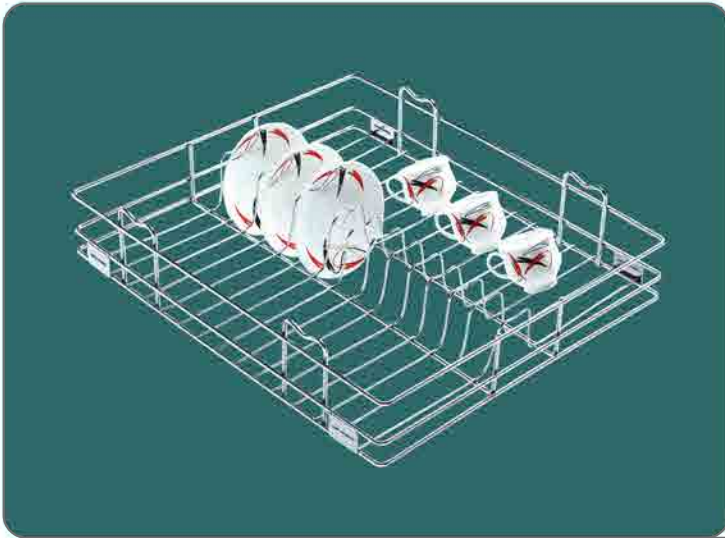

CUP & SAUCER BASKET

Width	375, 425, 475, 525	(mm)
Depth	505, 555	(mm)
Height	100	(mm)
Width	15, 17, 19, 21	(inch)
Depth	20, 22	(inch)
Height	4	(inch)

PERFORATED CUTLERY BASKET

Width	375, 425, 475, 525	(mm)
Depth	505, 555	(mm)
Height	100	(mm)
Width	15, 17, 19, 21	(inch)
Depth	20, 22	(inch)
Height	4	(inch)

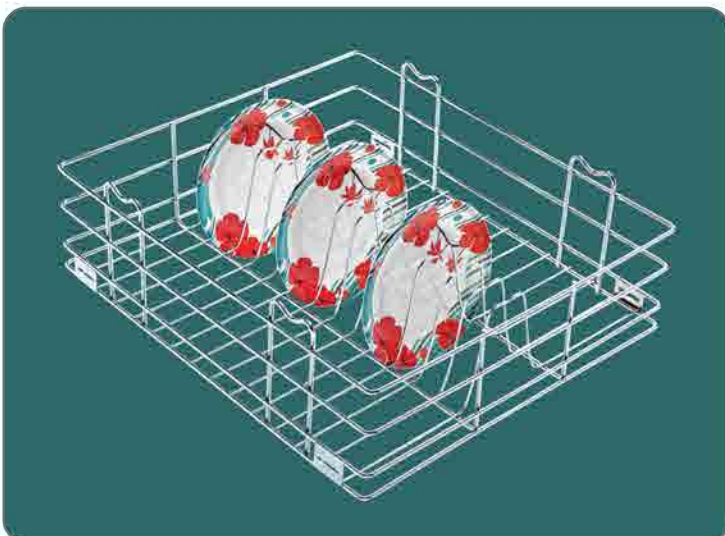
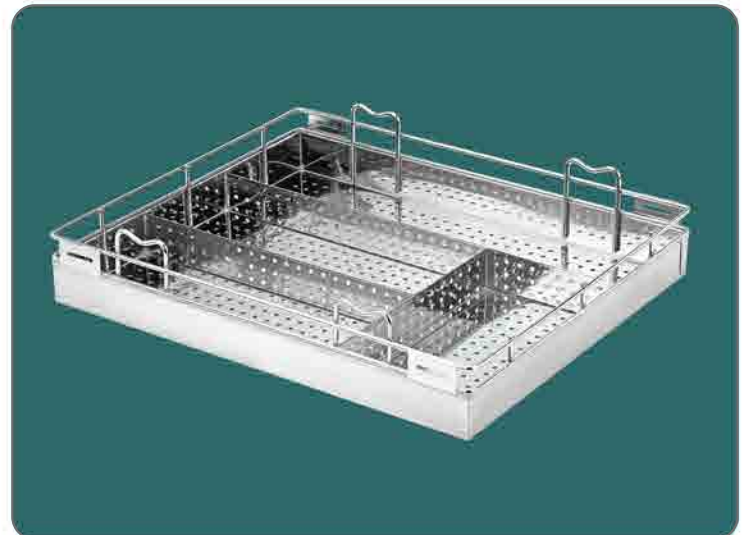

DISH BASKET

Width	375, 425, 475, 525	(mm)
Depth	505, 555	(mm)
Height	150	(mm)
Width	15, 17, 19, 21	(inch)
Depth	20, 22	(inch)
Height	6	(inch)

Green

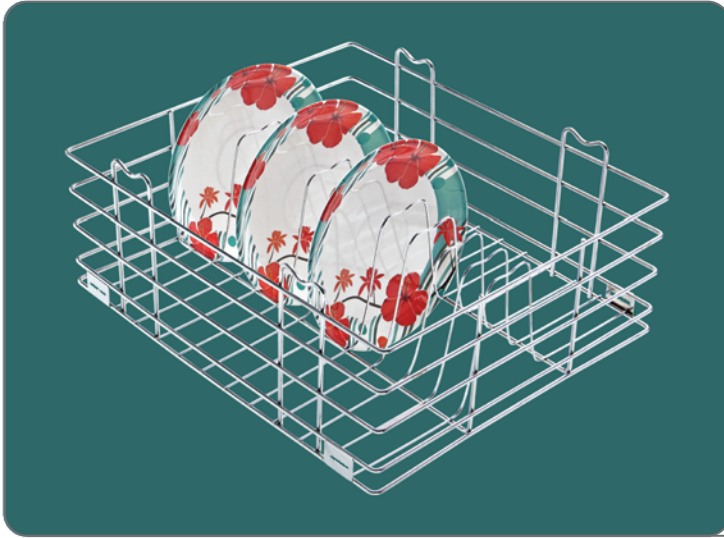

THALI BASKET

Width	375, 425, 475, 525	(mm)
Depth	505, 555	(mm)
Height	200	(mm)
Width	15, 17, 19, 21	(inch)
Depth	20, 22	(inch)
Height	8	(inch)

PLAIN BASKET

Width	375, 425, 475, 525	(mm)
Depth	505, 555	(mm)
Height	100, 150, 200	(mm)
Width	15, 17, 19, 21	(inch)
Depth	20, 22	(inch)
Height	4, 6, 8	(inch)



PARTITION BASKET

Width	375, 425, 475, 525	(mm)
Depth	505, 555	(mm)
Height	100, 150, 200	(mm)
Width	15, 17, 19, 21	(inch)
Depth	20, 22	(inch)
Height	4, 6, 8	(inch)



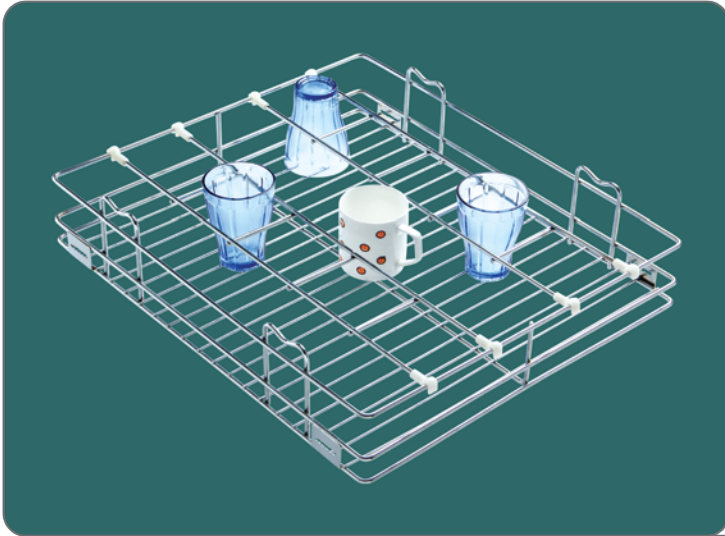

GLASS BASKET

Width	375, 425, 475, 525	(mm)
Depth	505, 555	(mm)
Height	100	(mm)
Width	15, 17, 19, 21	(inch)
Depth	20, 22	(inch)
Height	4	(inch)

BOTTLE BASKET

Width	375, 425, 475, 525	(mm)
Depth	505, 555	(mm)
Height	150	(mm)
Width	15, 17, 19, 21	(inch)
Depth	20, 22	(inch)
Height	6	(inch)

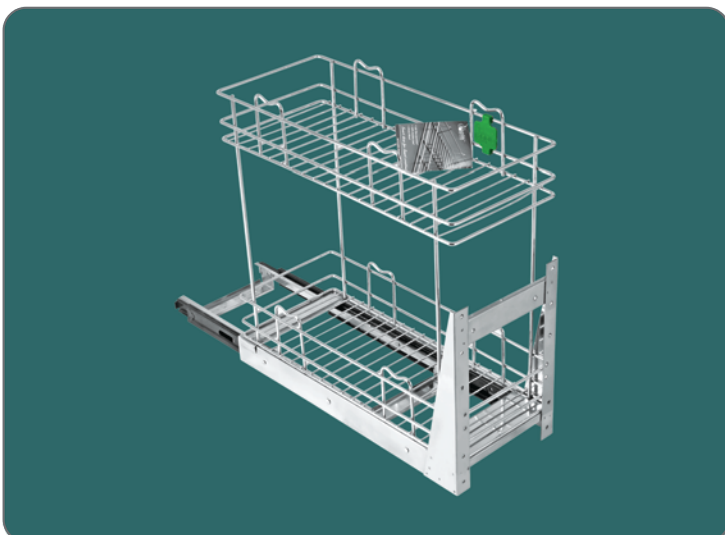

GRAIN PULL OUT WITH S.S. FRAME 2 SELF

Width	300, 200, 150	(mm)
Depth	505, 550	(mm)
Height	425	(mm)
Width	12, 8, 6	(inch)
Depth	20, 22	(inch)
Height	17	(inch)

Green



GRAIN PULL OUT WITH S.S. FRAME 3 SELF		
Width	300, 200, 150	(mm)
Depth	505, 550	(mm)
Height	600	(mm)
Width	12, 8, 6	(inch)
Depth	20, 22	(inch)
Height	24	(inch)



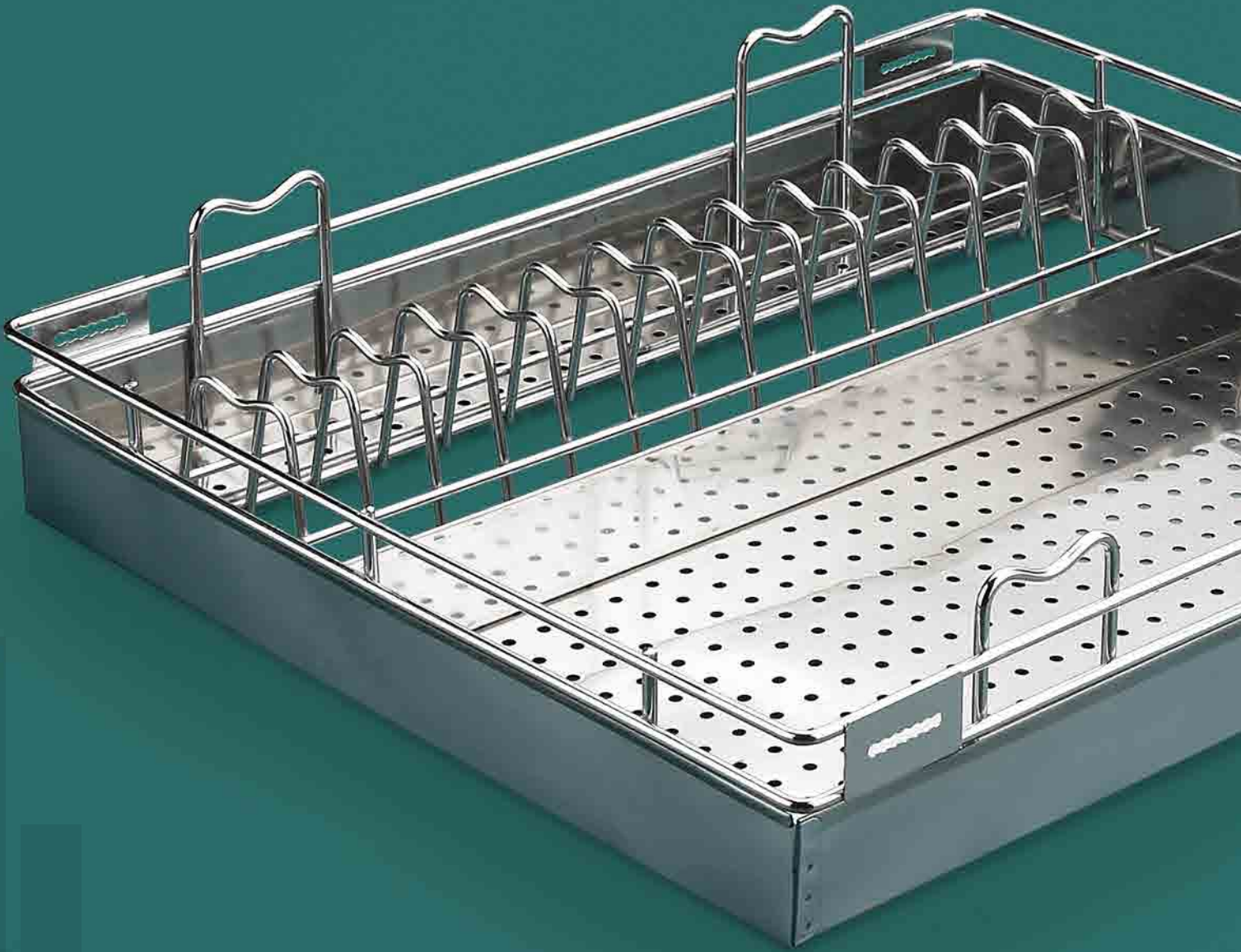

Yellow

“ Simply the most convenient way to store your precious sets of cup and saucers, this basket is made with precision to suite diverse sizes. It keeps the cutlery safe and protected, while giving you very easy and expedient access whenever you need them.”

CUP & SAUCER BASKET

Width	375, 425, 475, 525	(mm)
Depth	505, 555	(mm)
Height	100	(mm)
Width	15, 17, 19, 21	(inch)
Depth	20, 22	(inch)
Height	4	(inch)

Yellow

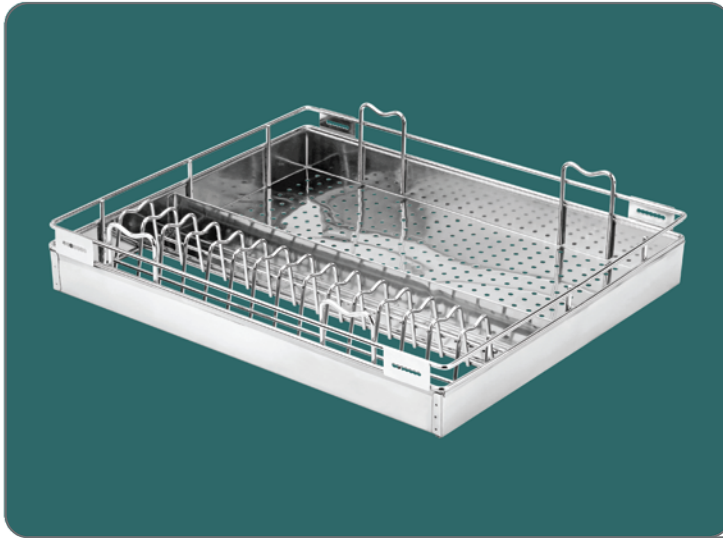

PERFORATED CUP & SAUCER BASKET

Width	375, 425, 475, 525	(mm)
Depth	505, 555	(mm)
Height	100	(mm)
Width	15, 17, 19, 21	(inch)
Depth	20, 22	(inch)
Height	4	(inch)

PERFORATED CUTLERY BASKET

Width	375, 425, 475, 525	(mm)
Depth	505, 555	(mm)
Height	100	(mm)
Width	15, 17, 19, 21	(inch)
Depth	20, 22	(inch)
Height	4	(inch)

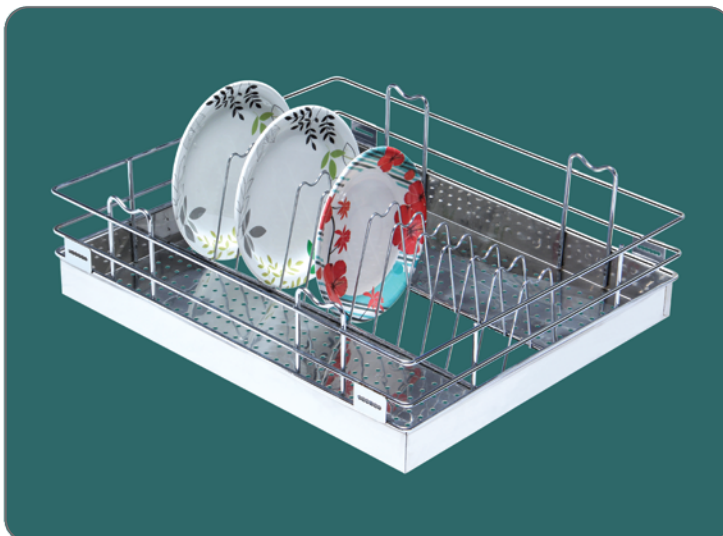
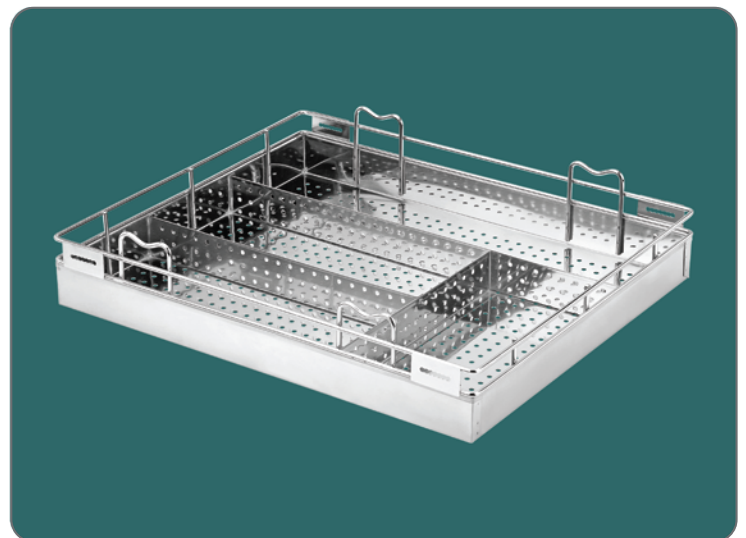

PERFORATED DISH BASKET

Width	375, 425, 475, 525	(mm)
Depth	505, 555	(mm)
Height	150	(mm)
Width	15, 17, 19, 21	(inch)
Depth	20, 22	(inch)
Height	6	(inch)

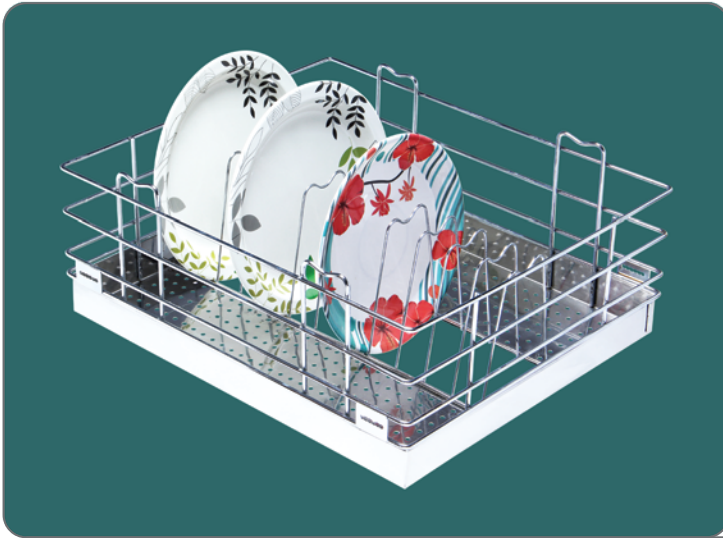

PERFORATED THALI BASKET

Width	375, 425, 475, 525	(mm)
Depth	505, 555	(mm)
Height	200	(mm)
Width	15, 17, 19, 21	(inch)
Depth	20, 22	(inch)
Height	8	(inch)

PERFORATED PLAIN BASKET

Width	375, 425, 475, 525	(mm)
Depth	505, 555	(mm)
Height	100, 150, 200	(mm)
Width	15, 17, 19, 21	(inch)
Depth	20, 22	(inch)
Height	4, 6, 8	(inch)

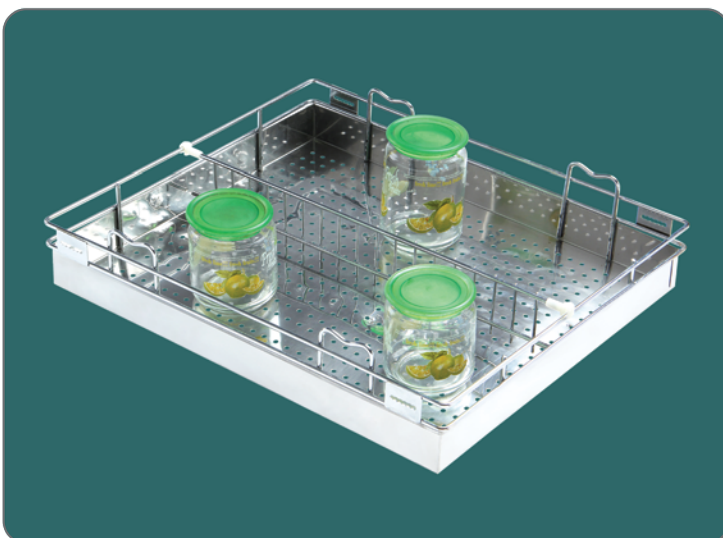

PERFORATED PARTITION BASKET

Width	375, 425, 475, 525	(mm)
Depth	505, 555	(mm)
Height	100, 150, 200	(mm)
Width	15, 17, 19, 21	(inch)
Depth	20, 22	(inch)
Height	4, 6, 8	(inch)

Yellow



PERFORATED GLASS BASKET

Width	375, 425, 475, 525	(mm)
Depth	505, 555	(mm)
Height	100	(mm)
Width	15, 17, 19, 21	(inch)
Depth	20, 22	(inch)
Height	4	(inch)

PERFORATED BOTTLE BASKET

Width	375, 425, 475, 525	(mm)
Depth	505, 555	(mm)
Height	150	(mm)
Width	15, 17, 19, 21	(inch)
Depth	20, 22	(inch)
Height	6	(inch)



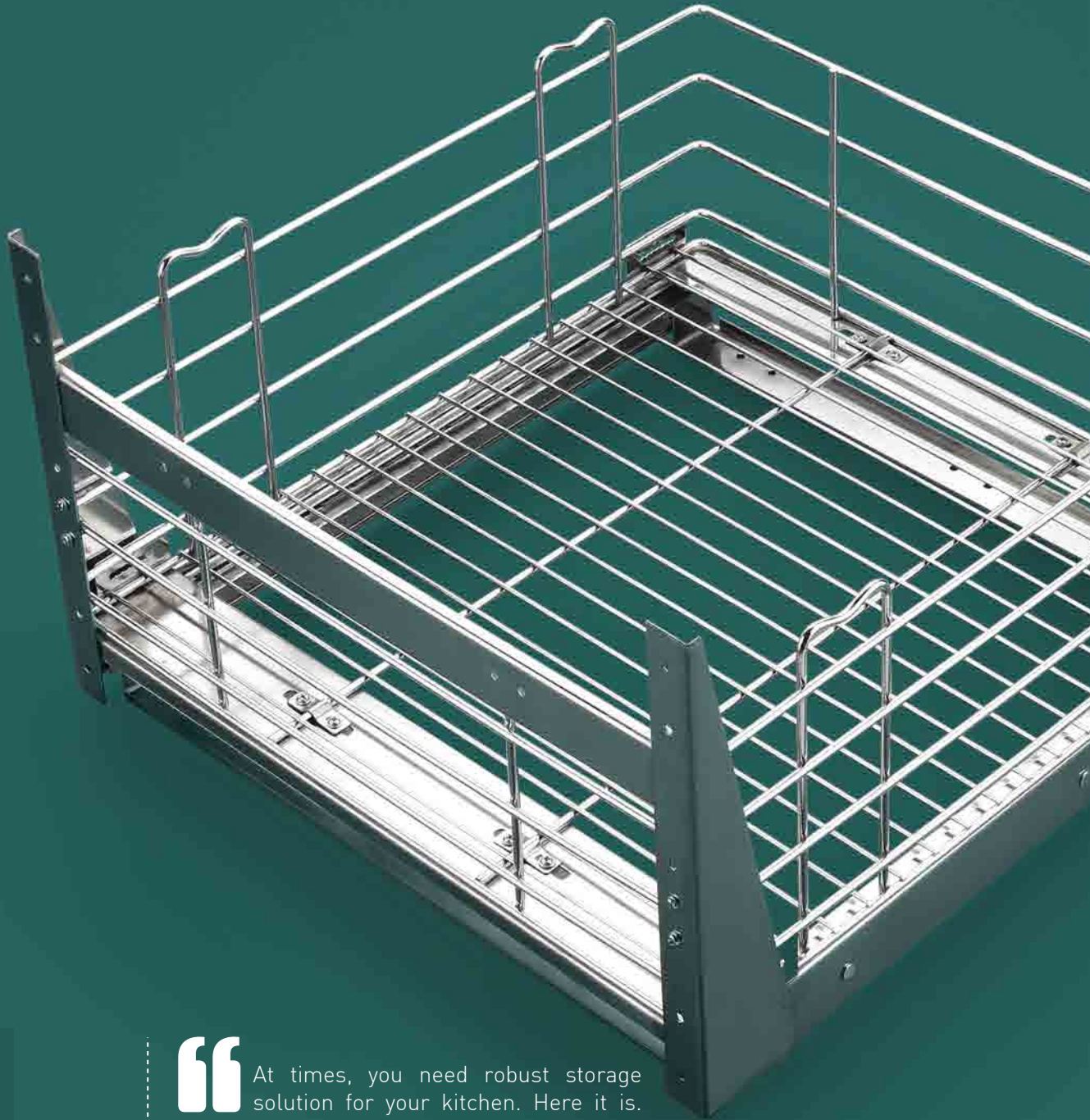

Blue

“

At times, you need robust storage solution for your kitchen. Here it is. Made with extra strong frame to withstand heavy load, this trolley is ideal to store anything in large quantity. And yes, though it is very sturdy, we have ensured that they remain very easy to use.”

”

GRAIN TROLLEY WITH S.S. FRAME

Width	375, 425, 475, 525	(mm)
Depth	505, 555	(mm)
Height	300	(mm)
Width	15, 17, 19, 21	(inch)
Depth	20, 22	(inch)
Height	12	(inch)

Blue



BOX VEGETABLE BASKET

Width	375, 425, 475, 525	(mm)
Depth	505, 555	(mm)
Height	150	(mm)
Width	15, 17, 19, 21	(inch)
Depth	20, 22	(inch)
Height	6	(inch)

GRAIN TROLLY WITH S.S. FRAME

Width	375, 425, 475, 525	(mm)
Depth	505, 555	(mm)
Height	300	(mm)
Width	15, 17, 19, 21	(inch)
Depth	20, 22	(inch)
Height	12	(inch)



FIX DOUBLE PULL OUT

Width	100, 150, 200	(mm)
Depth	505, 555	(mm)
Height	425	(mm)
Width	4, 6, 8	(inch)
Depth	20, 22	(inch)
Height	17	(inch)

Smart ideas for Smart creations

Blue



FIX TRIPLE PULL OUT

Width	100, 150, 200	(mm)
Depth	505, 555	(mm)
Height	600	(mm)
Width	4, 6, 8	(inch)
Depth	20, 22	(inch)
Height	24	(inch)



Blue

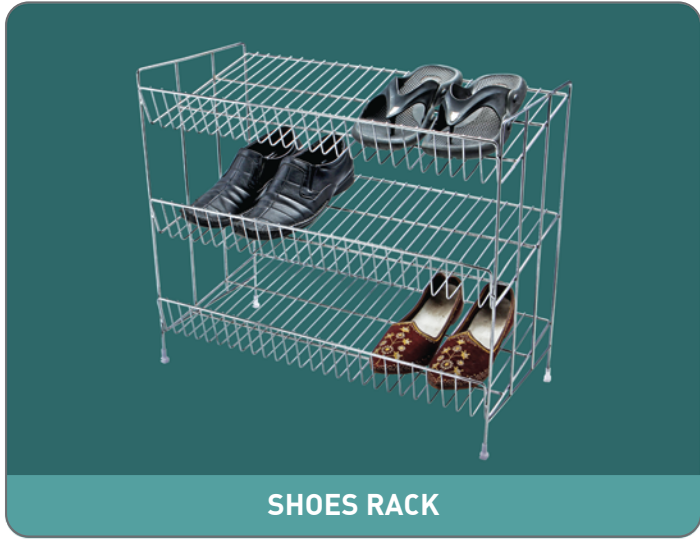
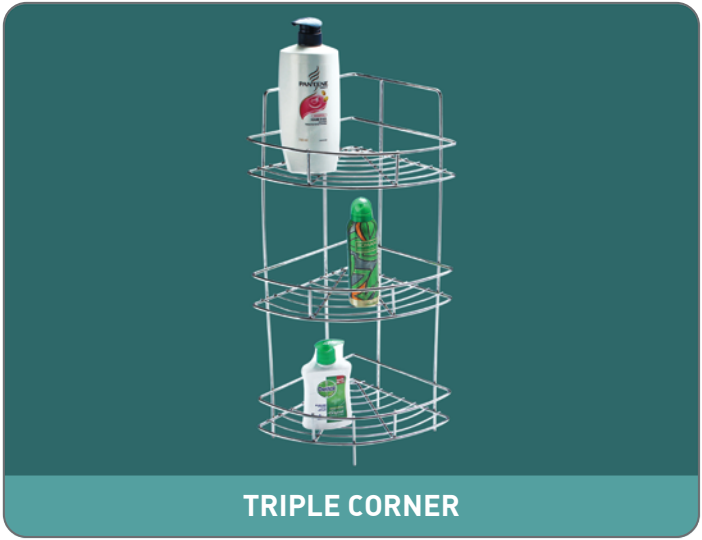
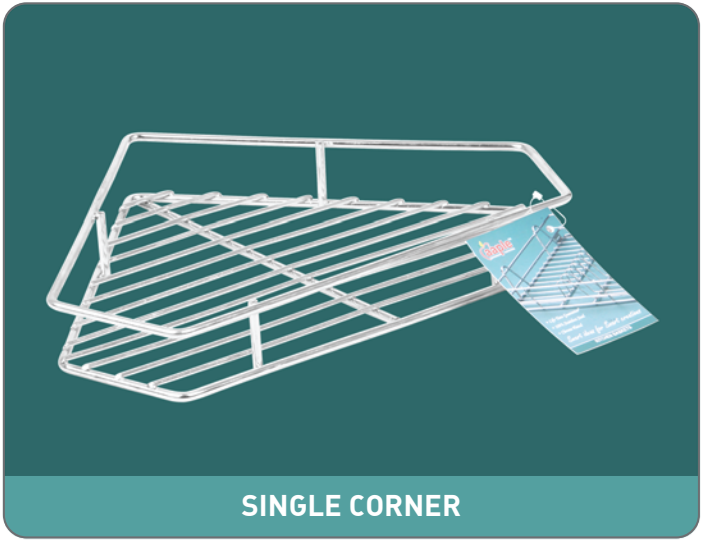



FRUIT BASKET

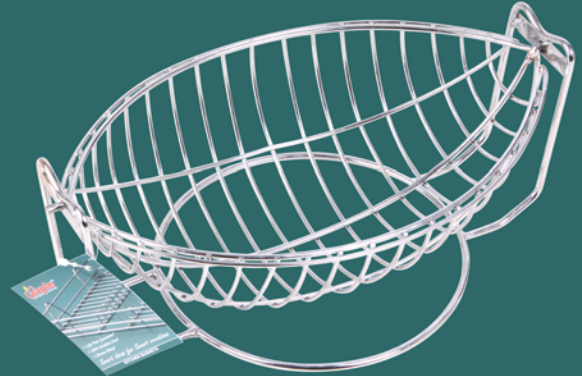

FRUIT BASKET (ZULA TYPE)



HOT PLATE



CUP & SAUCER RACK



GLASS RACK



HANGING DOUBLE RACK

Blue

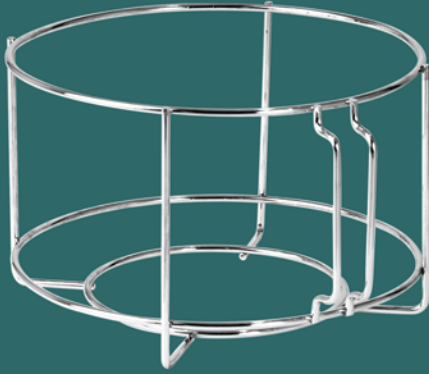

BIN HOLDER

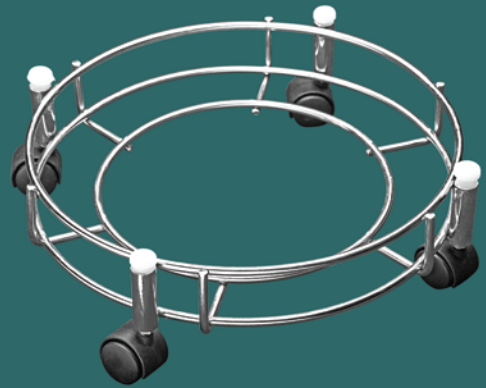

GAS CYLINDER TROLLEY

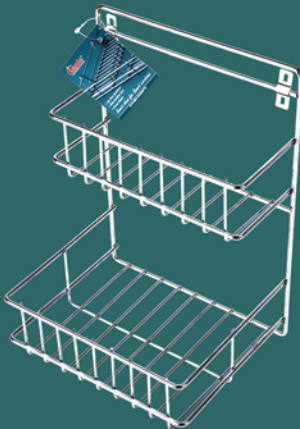

DETERGENT HOLDER

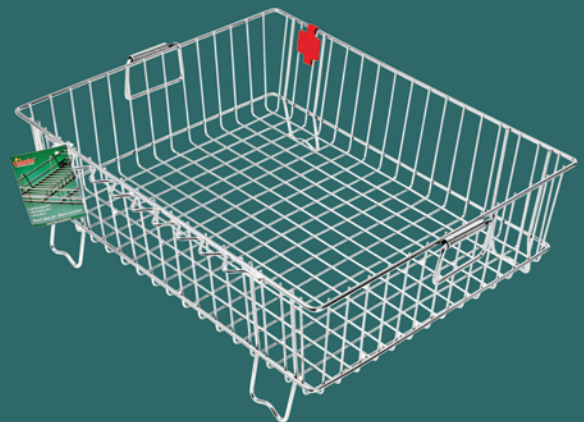

VESSEL DRYER STAND

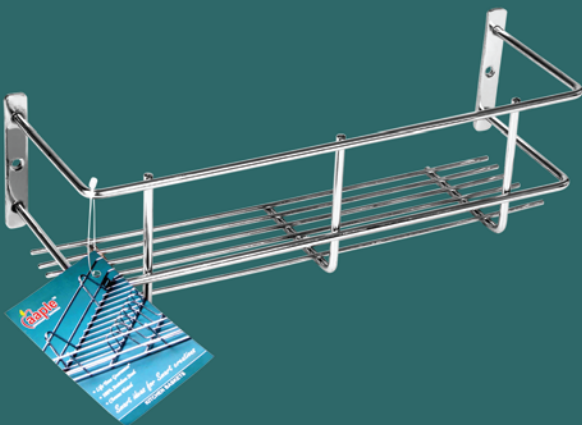

PERFUME RACK

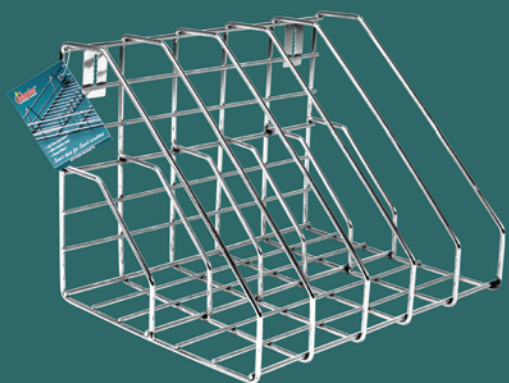

FILE STAND



SAUCER TANDEM STAND



DISH / THALI TANDEM STAND

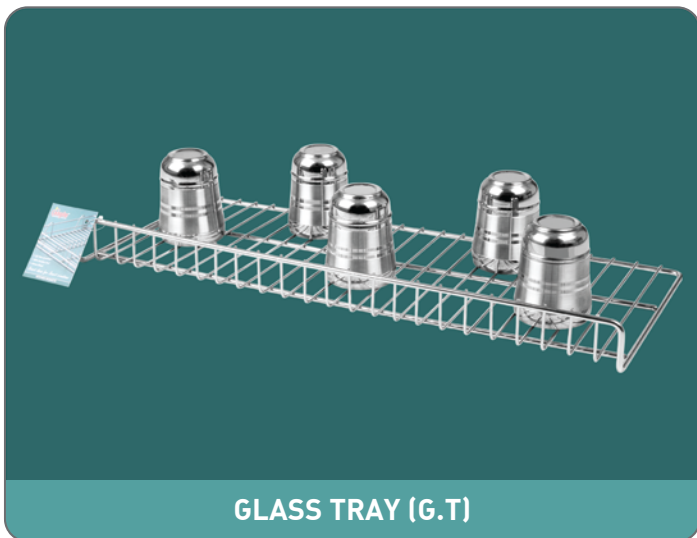

GLASS TRAY (G.T)

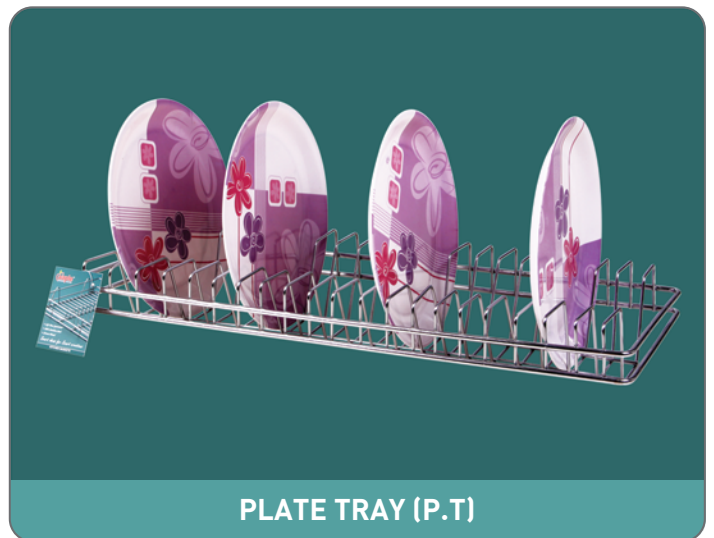

PLATE TRAY (P.T)



WINE GLASS STAND (SINGLE)



WINE GLASS STAND (DOUBLE)

Blue



PEDAL DUSTBIN



DUSTBIN



WIRE DUSTBIN

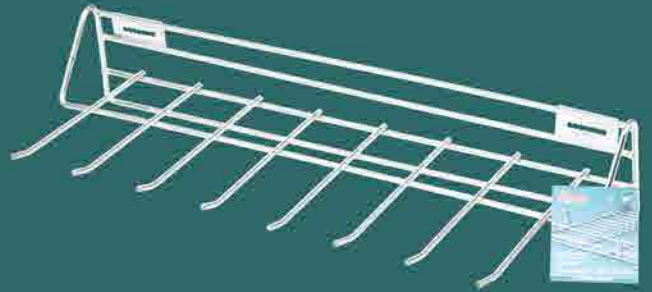

TIE SLIDER

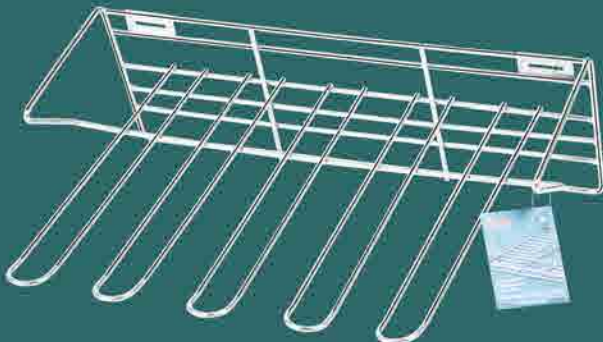

TROUSER / SAREE PULL OUT (PREMIUM)

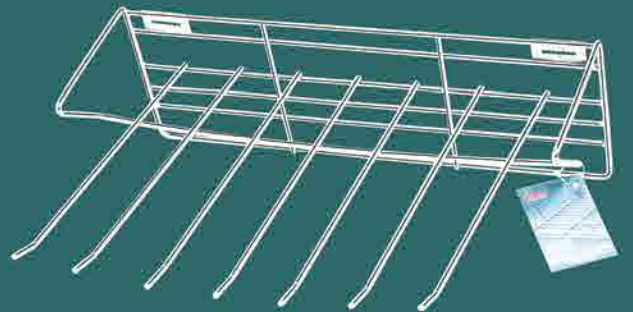

TROUSER / SAREE PULL OUT

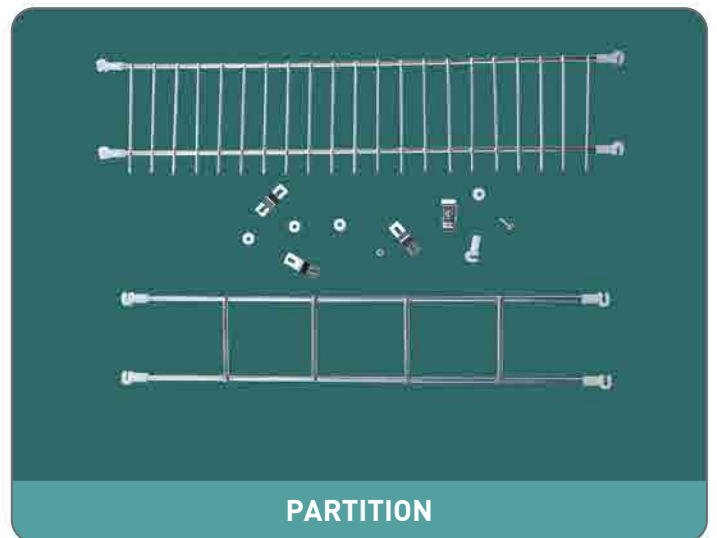
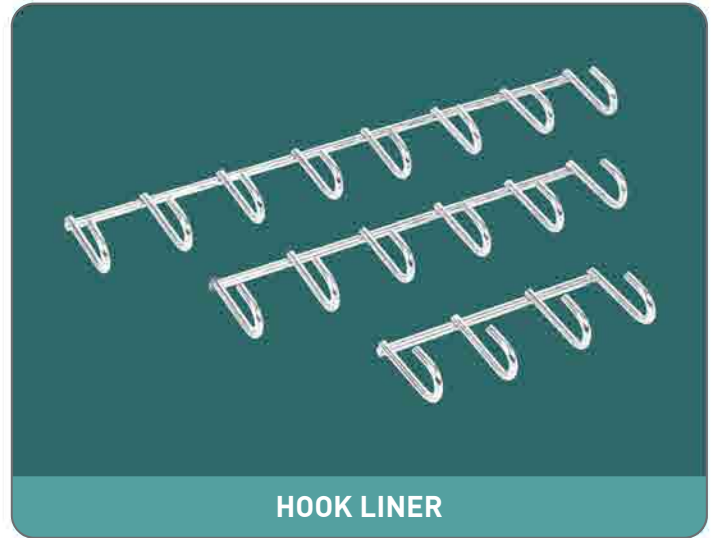

Blue



SINGLE PULL OUT

Width	125, 175, 225	(mm)
Depth	505, 555	(mm)
Height	600	(mm)
Width	5, 7, 9	(inch)
Depth	20, 22	(inch)
Height	24	(inch)

D TRAY

Width	500, 600, 700, 800	(mm)
Depth	100	(mm)
Height	750	(mm)
Width	20, 24, 28, 32	(inch)
Depth	4	(inch)
Height	30	(inch)

CARROUSEL

Width	500, 600, 700, 800	(mm)
Depth	100	(mm)
Height	750	(mm)
Width	20, 24, 28, 32	(inch)
Depth	4	(inch)
Height	30	(inch)



BOX PACKING





PREM STEEL INDUSTRIES

Plot. No.15, Paras Ind. Estate,
Opp. Lake Garden, Gajera Circle,
Katargam - Surat - 395 004 (Guj.) India

+91 0261 2486868
info@aapple.co.in / premsteelind@gmail.com
www.aapple.co.in